

MAXIM

Quad SPST CMOS Analog Switch

HI-201

General Description

The Maxim HI-201 monolithic CMOS quad single-pole-single-throw (SPST) analog switch is a plug-in upgrade for the Harris HI-201. Maxim has eliminated the need for a VREF supply, which is normally required for operation with power supplies other than $\pm 15V$. And Maxim's part consumes 1/4 the power (4mW typ), making it better suited for portable applications.

Maxim's switch can be continuously operated with power supplies ranging from $\pm 4.5V$ to $\pm 18V$, or single supplies over a range of +5V to +30V. Each switch can be independently selected and features fast switching ($t_{on} = 260ns$, $t_{off} = 100ns$ typ) and low on resistance (45 Ω typ). Maxim guarantees these switches will not latchup if the power supplies are disconnected with switch input signals still present. Logic inputs are both CMOS and TTL compatible without the need for pull-up resistors.

Applications

- Disk Drives
- Test Equipment
- Communication Systems
- PBX, PABX
- Guidance and Control Systems
- Heads-Up Displays

Features

- ◆ No VREF Supply Required
- ◆ Monolithic, Low-Power CMOS Design
- ◆ Guaranteed Single-Supply Operation from +5V to +30V
- ◆ Guaranteed $\pm 4.5V$ to $\pm 18V$ Operation
- ◆ Fast Switching Times: $t_{on} = 260ns$ (typ)
 $t_{off} = 100ns$ (typ)
- ◆ 45 Ω (typ) On Resistance
- ◆ Non-Latching with Supplies Turned Off and Input Signals Present
- ◆ CMOS and TTL Logic Compatible (0.8V/2.4V)

Ordering Information

PART	TEMP. RANGE	PIN-PACKAGE
HI3-0201-5	0°C to +70°C	16 Plastic DIP
HI6-0201-5	0°C to +70°C	16 Wide SO
HI1-0201-5	0°C to +70°C	16 CERDIP
HI0-0201-6	0°C to +70°C	Dice
HI3-0201-9	-40°C to +85°C	16 Plastic DIP
HI6-0201-9	-40°C to +85°C	16 Wide SO
HI1-0201-9	-40°C to +85°C	16 CERDIP
HI1-0201-2	-55°C to +125°C	16 CERDIP
HI4-0201-8*	-55°C to +125°C	20 LCC

* Contact Factory for Availability

Typical Operating Circuit

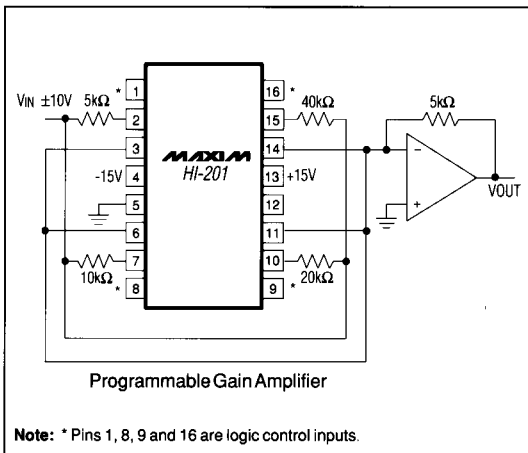

Pin Configurations

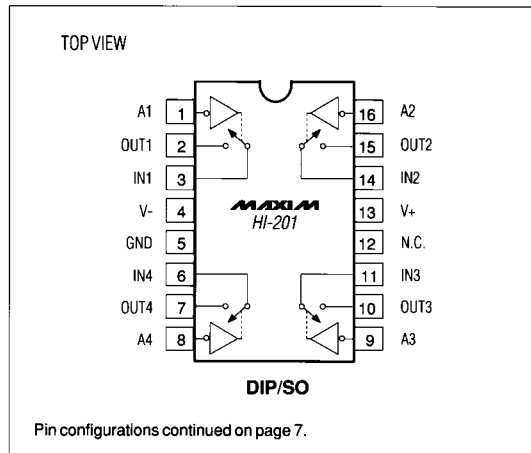

MAXIM

MAXIM is a registered trademark of Maxim Integrated Products.

Maxim Integrated Products 1

Quad SPST CMOS Analog Switch

HI-201

ABSOLUTE MAXIMUM RATINGS

Supply Voltage Between Pins 4 and 13	44V (± 22)	Operating Temperature	
VREF to Ground	+20V, -5V	HI_-0201-5,6	0°C to +70°C
Digital Input Voltage	+VSUPPLY +4V -VSUPPLY -4V	HI_-0201-9	-40°C to +85°C
Analog Input Voltage (One Switch)	+VSUPPLY +2.0V -VSUPPLY -2.0V	HI_-0201-2,8	-55°C to +125°C
Analog Current - Continuous, Peak	30mA, 80mA	Storage Temperature	-65°C to +150°C
Power Dissipation (any package)	.750mW	Power Dissipation (Note 1)	
Derate Above +75°C	8mW/°C	16-Pin CERDIP (Note 2)	900mW
		16-Pin Plastic DIP (Note 3)	470mW
		16-Pin Wide SO (Note 4)	400mW

- Note 1:** Device mounted with all pins soldered to PC board.
Note 2: Derate 12mW/°C above +75°C.
Note 3: Derate 6.5mW/°C above +25°C.
Note 4: Derate 7mW/°C above +25°C.

Stresses listed under "Absolute Maximum Ratings" may be applied (one at a time) to devices without resulting in permanent damage. These are stress ratings only, and functional operation of the device at these or any other conditions above those indicated in the operational sections of the specifications is not implied. Exposure to absolute maximum ratings conditions for extended periods may affect device reliability.

ELECTRICAL CHARACTERISTICS

(V+ = +15V, V- = -15V, GND = 0V, TA = +25°C, unless otherwise noted.)

PARAMETER	SYMBOL	CONDITIONS	LIMITS						UNITS	
			HI_-0201-2/8			HI_-0201-5/6/9				
			MIN	TYP	MAX	MIN	TYP	MAX		
SWITCH										
Analog-Signal Range	VANALOG		-15		15	-15		15	V	
Drain-Source On Resistance (Note 7)	rDS (on)	VD = ± 10 V, VIN = 0.8V, IS = 1mA		45	70		45	80	Ω	
Source-Off Leakage Current	IS (off)	VIN = 2.4V	VS = 14V, VD = -14V	-5	± 0.01	5	-10	± 0.01	10	nA
			VS = -14V, VD = 14V	-5	± 0.02	5	-10	± 0.02	10	
Drain-Off Leakage Current	ID (off)	VIN = 2.4V	VD = 14V, VS = -14V	-5	± 0.01	5	-10	± 0.01	10	nA
			VD = -14V, VS = 14V	-5	± 0.02	5	-10	± 0.02	10	
Drain-On Leakage Current (Note 8)	ID (on)	VS = -14V, VIN = 0.8V	-5	± 0.1	5	-10	± 0.1	10	nA	
		VD = 14V, VIN = 0.8V	-5	± 0.15	5	-10	± 0.15	10		
LOGIC INPUT										
Input Current with Input Voltage High	IINH	VIN = 2.4V	-1	± 0.0004	1	-1	± 0.0004	1	μ A	
		VIN = 15V	-1	0.003	1	-1	0.003	1		
Input Current with Input Voltage Low	IINL	VIN = 0V	-1	± 0.0004	1	-1	± 0.0004	1	μ A	

Quad SPST CMOS Analog Switch

HI-201

ELECTRICAL CHARACTERISTICS (continued)

(V+ = +15V, V- = -15V, GND = 0V, TA = +25°C, unless otherwise noted.)

PARAMETER	SYMBOL	CONDITIONS	LIMITS						UNITS
			HI_-0201-2/8			HI_-0201-5/6/9			
			MIN (Note 5)	TYP (Note 6)	MAX	MIN (Note 5)	TYP (Note 6)	MAX	
DYNAMIC									
Turn-On Time	ton	See Switching-Time Test Circuit	260	400		260	500		ns
Turn-Off Time	toff	See Switching-Time Test Circuit	100	300		100	350		ns
Charge Injection	Q	CL = 1000pF, VGEN = 0V, RGEN = 0Ω	20			20			pC
Source-Off Capacitance	CS (off)	VS = 0V, VIN = 5V		f = 140kHz	5		5		pF
Drain-Off Capacitance	CD (off)	VS = 0V, VIN = 5V		f = 140kHz	5		5		pF
Channel-On Capacitance	CD (on) ⁺ CS (on)	VD = VS = 0V, VIN = 0V		f = 140kHz	16		16		pF
Off Isolation		VIN = 5V, ZL = 75Ω			70		70		dB
Crosstalk (Channel-to-Channel)		VS = 2.0V, f = 100kHz			90		90		dB
SUPPLY									
Positive Supply Current	I+	All Channels On or Off	0.2	0.3		0.2	0.3		mA
Negative Supply Current	I-		-0.1	-0.01		-0.1	-0.01		mA
Power-Supply Range for Continuous Operation	VOP	(Note 7)	±4.5		±18	±4.5		±18	V

Note 5: The algebraic convention where the most negative value is a minimum and the most positive a maximum is used in this data sheet.

Note 6: Typical values are for DESIGN AID ONLY, not guaranteed or subject to production testing.

Note 7: Electrical characteristics, such as on resistance, will change when power supplies other than ±15V are used.

Note 8: ID(on) is leakage from driver into on switch.

Quad SPST CMOS Analog Switch

HI-201

ELECTRICAL CHARACTERISTICS

(V+ = +15V, V- = -15V, GND = 0V, TA = TMIN to TMAX)

PARAMETER	SYMBOL	CONDITIONS	LIMITS						UNITS
			HI_-201-2/7/8			HI_-201-5/6/9			
			MIN (Note 5)	TYP (Note 6)	MAX	MIN (Note 5)	TYP (Note 6)	MAX	
SWITCH									
Analog-Signal Range	VANALOG		-15		15	-15		15	V
Drain-Source On Resistance (Note 9)	rDS (on)	VD = ±10V, VIN = 0.8V, IS = 1mA			100			100	Ω
Source-Off Leakage Current	IS (off)	VIN = 2.4V	VS = 14V, VD = -14V		500			250	nA
			VS = -14V, VD = 14V	-500		-250			
Drain-Off Leakage Current	ID (off)	VIN = 2.4V	VD = 14V, VS = -14V		500			250	nA
			VD = -14V, VS = 14V	-500		-250			
Drain-On Leakage Current (Note 10)	ID (on)	VS = -14V, VIN = 0.8V			500			250	nA
		VD = 14V, VIN = 0.8V	-500		-250				
LOGIC INPUT									
Input Current with Input Voltage High	IINH	VIN = 2.4V	-1.0			-1.0			μA
		VIN = 15V		1.0			1.0		
Input Current with Input Voltage Low	IINL	VIN = 0V	-1.0			-1.0			μA
DYNAMIC									
Turn-On Time	ton	See Switching-Time Test Circuit			500			600	ns
Turn-Off Time	toff	See Switching-Time Test Circuit			400			450	ns
SUPPLY									
Positive Supply Current	I+	All Channels On or Off			0.4			0.4	mA
Negative Supply Current	I-	All Channels On or Off	-0.1			-0.1			mA

Note 9: Electrical characteristics, such as on resistance, will change when power supplies other than ±15V are used.

Note 10: ID(on) is leakage from driver into on switch.

Quad SPST CMOS Analog Switch

HI-201

Protecting Against Fault Conditions

Fault conditions occur when power supplies are turned off and input signals are still present, or overvoltages occur at the inputs during normal operation. In either case, source-to-body diodes can be forward biased and conduct current from the signal source. If this current is required to be kept to low (μA) levels, the addition of external protection diodes is recommended (Figure 1).

To provide protection for overvoltages up to 20V above the supplies, a 1N4001 or 1N914 type diode should be placed in series with the positive and negative supplies, as shown in Figure 1. The addition of these diodes will reduce the analog-signal range to 1V below the positive supply and 1V above the negative supply.

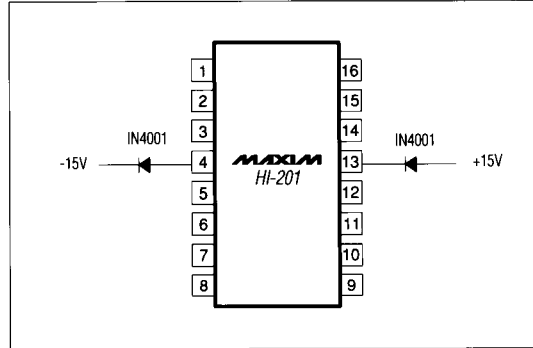

Figure 1. Protection Against Fault Conditions

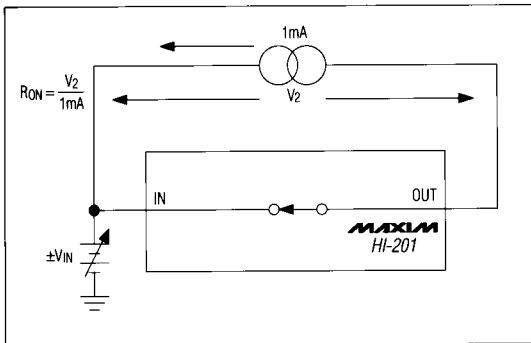

Figure 2. On Resistance vs. Analog-Signal Level Supply Voltage

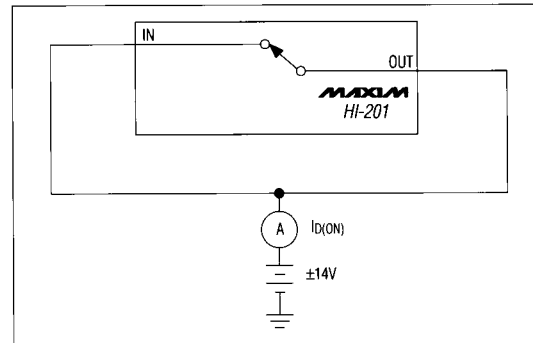

Figure 3. On Leakage Current

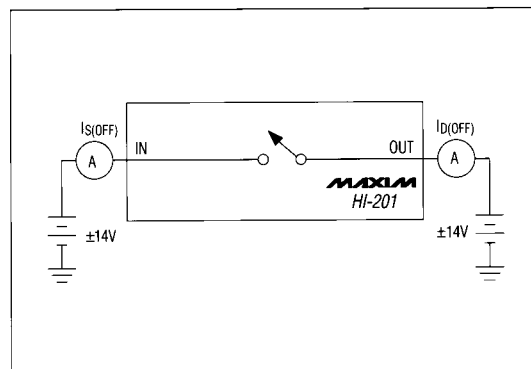

Figure 4. Off Leakage Current

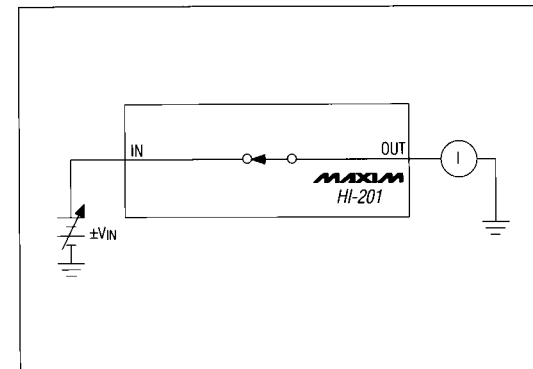
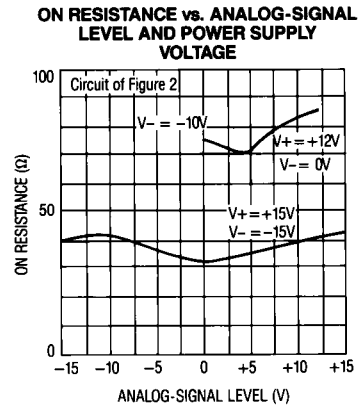
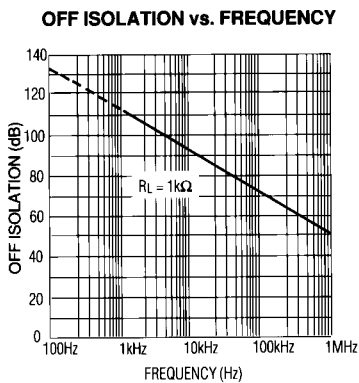
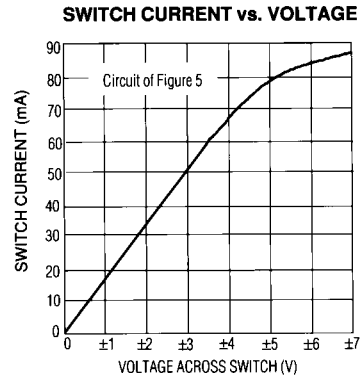
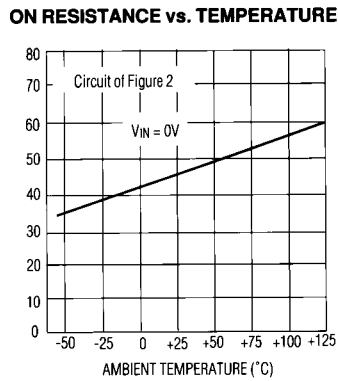
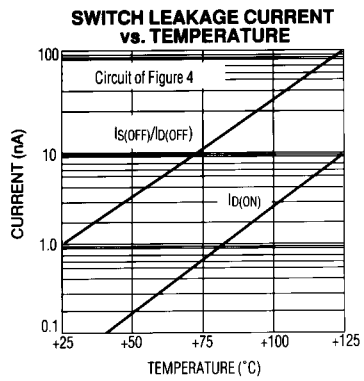

Figure 5. Switch Current vs. Voltage

Quad SPST CMOS Analog Switch

Typical Operating Characteristics



Quad SPST CMOS Analog Switch

Pin Configurations (continued)

HI-201

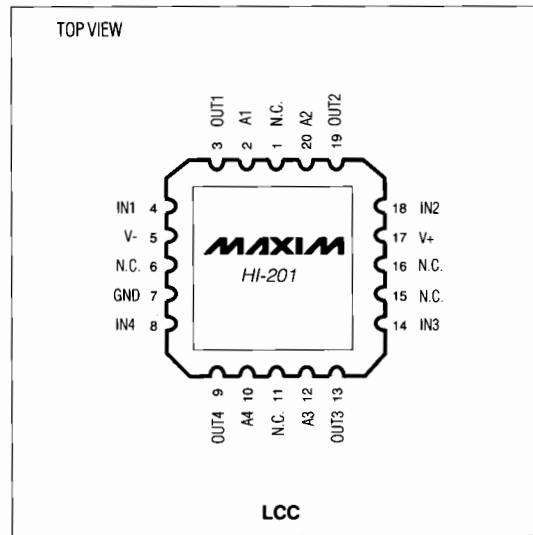
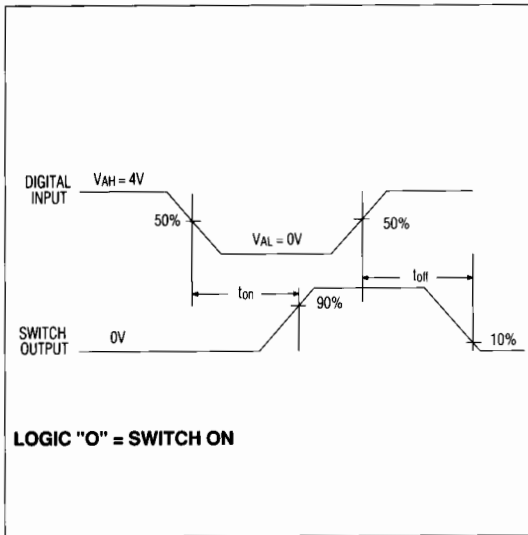
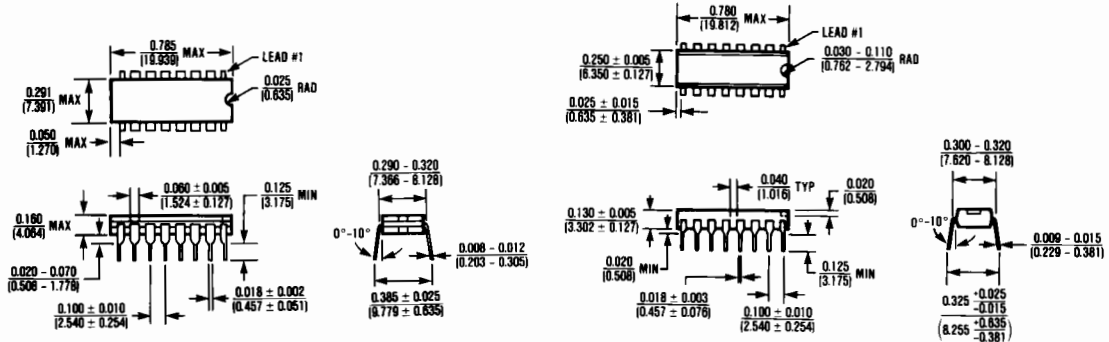

Figure 6. HI-201 Switch Timing

Quad SPST CMOS Analog Switch

HI-201

Package Information



16 Lead CERDIP (HI1)

$\theta_{JA} = 100^{\circ}\text{C/W}$
 $\theta_{JC} = 50^{\circ}\text{C/W}$

16 Lead Plastic DIP (HI3)

$\theta_{JA} = 135^{\circ}\text{C/W}$
 $\theta_{JC} = 65^{\circ}\text{C/W}$

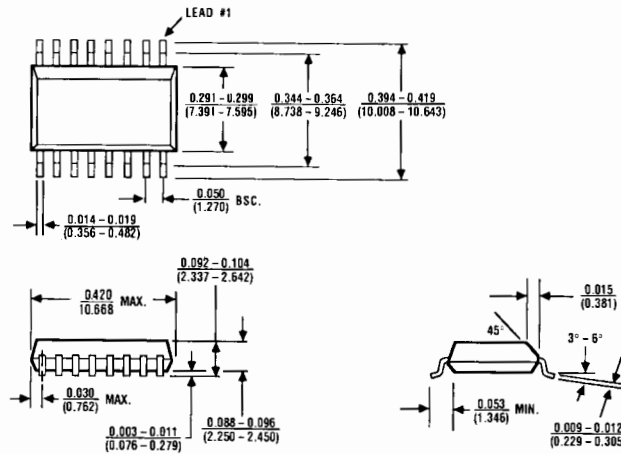

16 Lead Small Outline, Wide (W16)

$\theta_{JA} = 105^{\circ}\text{C/W}$
 $\theta_{JC} = 60^{\circ}\text{C/W}$

Maxim cannot assume responsibility for use of any circuitry other than circuitry entirely embodied in a Maxim product. No circuit patent licenses are implied. Maxim reserves the right to change the circuitry and specifications without notice at any time.

8 Maxim Integrated Products, 120 San Gabriel Drive, Sunnyvale, CA 94086 (408) 737-7600